

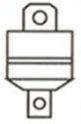







# ROTATORI IDRAULICI - HYDRAULIC ROTATORS

FR

	 static Kg	 dinamic Kg	 Kg	 Bar		 Nm	 L/min
FR 15	1200	600	10	250	360° cont.	500	10
FR 35	3500	1750	17	250	360° cont.	700	20
FR 35 F	3500	1750	22	250	360° cont.	700	20
FR 50	5000	2500	25	250	360° cont.	1100	20
FR 50 F	5000	2500	28	250	360° cont.	1100	20
FR 65	6500	3250	38	250	360° cont.	1750	25
FR 65 F	6500	3250	41	250	360° cont.	1750	25
FR110FSH	11000	5500	56	250	360° cont.	2500	30
FR110FDH	11000	5500	59	250	360° cont.	2500	30
FR 160 FS	16000	8000	70	250	360° cont.	3500	40

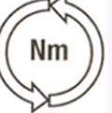

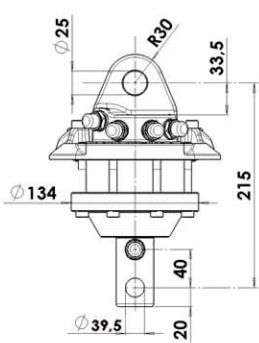
FR 15

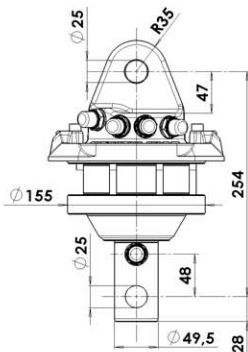

FR 35

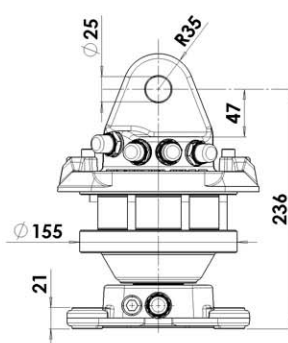

FR 35F

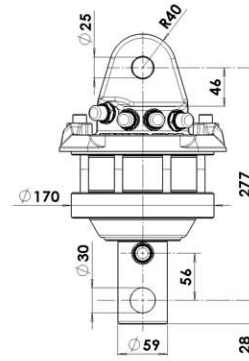

FR 50

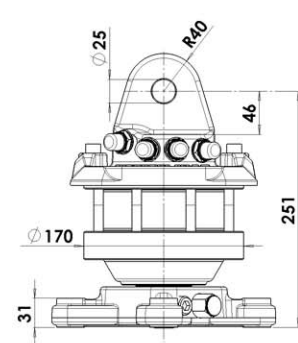

FR 50F

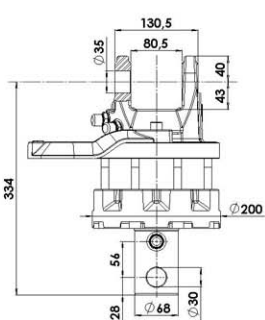

FR 65

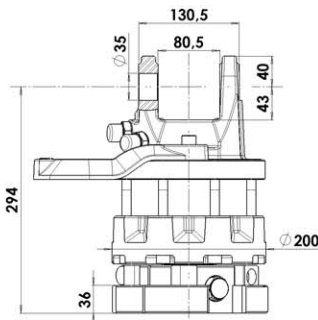

FR 65F

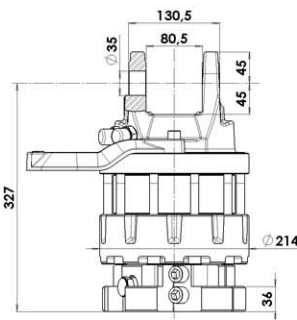

FR 110F SH

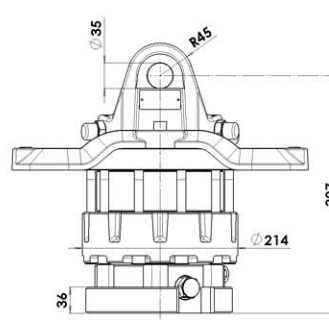

FR 110F DH

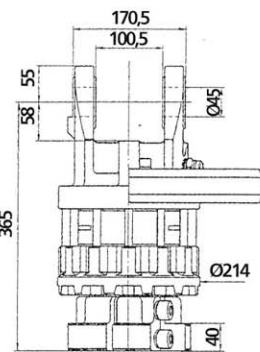

FR 160FS

\* Le specifiche tecniche e le dimensioni riportate non sono impegnative, e Ferrari International 2 si riserva il diritto di apportare le modifiche che dovessero manifestarsi necessarie senza preavviso.  
\* The specifications and dimensions indicated are not binding; Ferrari International 2, therefore, reserves the right to make changes at any time.